

LIVIX

Automation for residential sliding gates
up to 900 Kg



For residential usage



Available in 230V and 24V

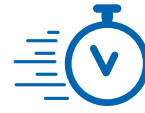

#fastasyoulike!
Standard or fast speed
motors (16 m/min for art.
LIVI 6/24X/M-BOOST)



LIVI/X

Improved aesthetics and features



Additional protection of the release system for increased reliability. New transparent control unit box with easy opening system.

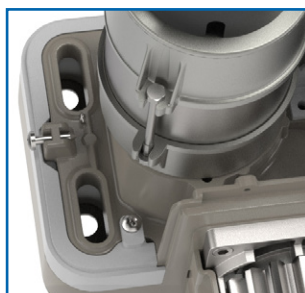

New slotted fixing holes offer greater adjustment during installation, ensuring backward compatibility with previous LIVI models



New design with the possibility of installing an LED strip (optional LED kit - **available Q2 2024**)

New ABS crankcase for greater weather resistance. Increased degree of protection compared to previous models (IP44)



The LIVI/X is equipped with a new magnetic limit switch system, consisting of a new technology sensor and a set of magnets attached to the multi-adjustable rack.



LIVI/X	Opening speed	10 m/min
LIVI/X-BOOST		16 m/min

Note: the opening speed could decrease according to the installation characteristics

Reliability as always



All our products are made with high quality materials, such as steel and bronze, which guarantee reliability over time.



Compatible with external cable release (item 450N and item BLINDOS - optional), to always have safe access from outside the property



Battery kit with dedicated support (optional for 24V models), to guarantee operation during power outages



230V versions are equipped with a physical encoder for better control and obstacle detection



The DE@NET universal control board makes this operator compatible with the NETLINK System.



Compatible with NETCOM, the device for installation, maintenance and remote management, from your office!



Models

230V ~ operator with control board, limit switches and encoder



COD.	Art.	DEA	⚡	⚖️	ENCODER	🏁	kg	📱	OTHER CHARACTERISTICS
611000	LIVI 6X/M	NET230N	230V	600 kg	✓	M	11	48	<ul style="list-style-type: none"> • Self-locking with magnetic limit switch • Speed adjustment and slow down in opening and closing • Motor control by encoder and obstacle detection • Anti-crashing safety device
612000	LIVI 9X/M	NET230N	230V	900 kg	✓	M	12,5	48	

All models have: control board and fixing plate (to be screwed) included

24V = operators with control board and limit switches



COD.	Art.	DEA	⚡	⚖️	ENCODER	🏁	kg	📱	OTHER CHARACTERISTICS
611100	LIVI 6/24X/M	NET24N	24V	600 kg		M	12	48	<ul style="list-style-type: none"> • Self-locking with magnetic limit switch • Speed adjustment and slow down in opening and closing • Anti-crashing safety device • Versions with increased speed only in BOOST models (16m/min)
611110	LIVI 6/24X/M-BOOST (16m/min)	NET24N	24V	600 kg		M	12	48	
612100	LIVI 9/24X/M	NET24N	24V	900 kg		M	12	48	

All models have: control board and fixing plate (to be screwed) included

212E 230V ~ operators with control board and limit switches



COD.	Art.	DEA	⚡	⚖️	ENCODER	🏁	kg	📱	OTHER CHARACTERISTICS
611010	LIVI 6X/E/M*	212E	230V	600 kg		M	11	48	<ul style="list-style-type: none"> • ATTENTION: not compatible with NETLINK • Self-locking with magnetic limit switch • Electronic force adjustment • Automatic working time learning • Controlled input for external safety device
612010	LIVI 9X/E/M*	212E	230V	900 kg		M	12,5	48	

All models have: control board and fixing plate included

KIT LIVI/X

COD.	Art.		⚖️	kg	📱
611200	KIT LIVI 6X/M	LIVI 6X/M (NET230N) + LINEAR + AURA/N + 2xGTI2 + 127	600	11,8	48
612200	KIT LIVI 9X/M	LIVI 9X/M (NET230N) + LINEAR + AURA/N + 2xGTI2 + 127	900	13,2	48
611300	KIT LIVI 6/24X/M	LIVI 6/24X/M (NET24N) + LINEAR + AURA/N + 2xGTI2	600	12,8	48
611310	KIT LIVI 6/24X/M-BOOST	LIVI 6/24X/M-BOOST (NET24N) + LINEAR + AURA/N + 2xGTI2 + 127	600	12,8	48
612300	KIT LIVI 9/24X/M	LIVI 9/24X/M (NET24N) + LINEAR + AURA/N + 2xGTI2 + 127	900	12,8	48

Example of a typical installation

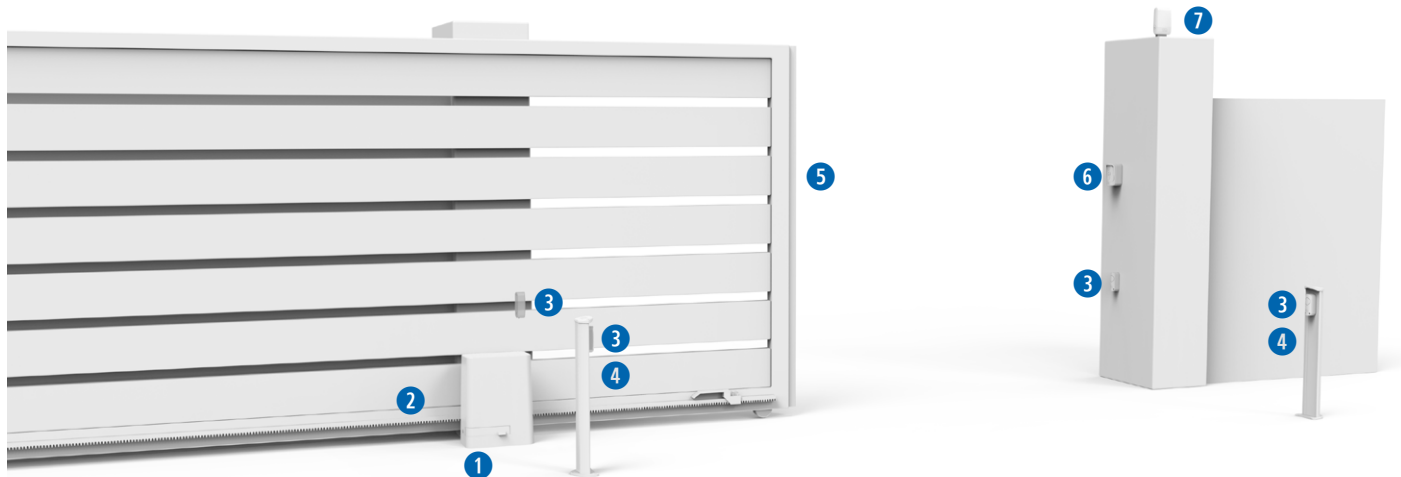

KIT

1  **COD. 611000**
Art. LIVI 6X/M
Automation for residential sliding gates

2  **COD. 619000**
Art. 111
Nylon rack, with fixing screws (1m)

KIT

3  **COD. 662044**
Art. LINEAR
Pair of adjustable photocells (180 degree) with possibility of synchronized operating. Range 20m

4  **COD. 664000**
Art. PILLY/60
Pair of 55cm column for photocells (2 pcs)

5  **COD. 171035**
Art. C-20
Mechanical edge L=2m

6  **cod. 663090**
Art. GT-KEY/SB
Metal vandal proof keyswitch with two contacts, surface mounted. Supplied with 2 keys.

KIT

7  **COD. 661130**
Art. AURA N
LED flashing light, multi-voltage 24V AC-DC/120V AC/230V AC, with integrated antenna 433MHz/868MHz

KIT

 **COD. 672635**
Art. GTI2
Serialized white 2-channel remote control, 433 MHz, with 3 coding options: HCS Rolling-Code, Dip-Switch and new D.A.R.T. coding.

KIT for further details on the kits see price list

Specific accessories

COD. 619000
Art. 111
Nylon rack, with fixing screws (1m)

COD. 126001
Art. 112
Galvanized steel rack 22x22mm (1m)

COD. 126000
Art. 113
Galvanized steel rack 30x12mm with zinc-plated spacers and fixing screws (1m)

COD. 619042
Art. 450N
Unlocking device by cable for LIVI/X (4,5m). To be used with BLINDOS

COD. 619013
Art. 460N V2
Additional foundation plate for LIVI/X

COD. 672920
Art. D-BAND KIT
Wireless transmitter and receiver kit in 868 MHz, for resistive or mechanical safety edges

COD. 171034
Art. C-16
Mechanical edge L=1.6m

COD. 171035
Art. C-20
Mechanical edge L=2m

COD. 171039
Art. CR-20
Resistive edge L=2m

COD. 171040
Art. CR-25
Resistive edge L=2,5m

COD. 171044
Art. CC-20
Conductive edge L=2m

COD. 667053
Art. SOFT3
Safety rubber profile (complete with aluminium base) useful to reduce the impact forces for sliding and swing gates (12m)

COD. 665000
Art. BLINDOS
Aluminium safety enclosure, with European cylinder, ready for unlocking device by cable.

COD. 619014 **NEW**
Art. KIT ADA LIVI MULTIBRAND
Base for multi-brand plate adaptation

COD. 619015 **NEW**
Art. KIT ADA LIVI/N
Kit for replacing LIVI/N with LIVI/X

COD. 661140
Art. KIT LED/X
Led kit for GEKO/X and LIVI/X consisting of 60 cm COB led strip (white light) + power supply + relay

COD. 661141
Art. LED/X
60 cm COB led strip (white light), without power supply (for second operator)

COD. 629293 **NEW**
Art. KIT BAT LIVI/X-GEKO/X
Rechargeable batteries kit, 12V - 1,2Ah, complete with wiring cables and fixing plate for GEKO/X and LIVI/X



Technical info

	LIVI 6X/M LIVI 6XE/M	LIVI 9X/M LIVI 9XE/M	LIVI 6/24X	LIVI 6/24X/M BOOST	LIVI 9/24X/M
Motor power supply (V)	230 - 240 V ~ (50/60 Hz)				
Motor power supply voltage (V)	230 V ~		24 V ===		
Maximum Power (W)	320	450	80		110
Max thrust (N)	340	490	210	240	260
Duty cycle (cycles/hour) Gate L=5 metres	18	11	22		18
N. max cycles in 24h. Gate L=5 metres	60	40	60		40
Leaf max weight (kg)	600	900	600		900
Built-in capacitor (µF)	8	12,5	-		
Motor thermal protection (°C)	140°C	160°C	-		
Operating temperature (°C)	-20÷50 °C				
Speed (m/min)	10		10	16	10
Standard pinion	Z=16 (m=4mm)				
Weight with packing (Kg)	11	12,5	12		
Sound pressure (dBA)	< 70				
Protection level	IP44				

Wiring

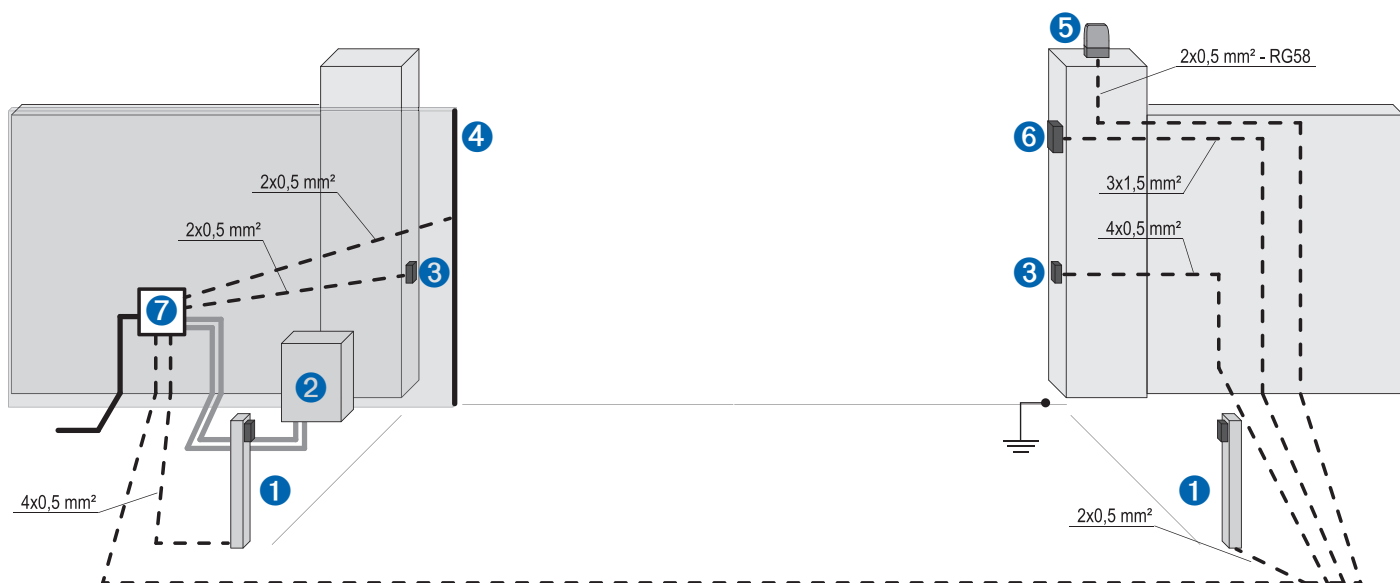

pos.	description
1	Column with photocell
2	Operator
3	Photocells
4	Safety edge
5	Flashing light
6	Keyswitch / Digikey
7	Junction box

Dimensions

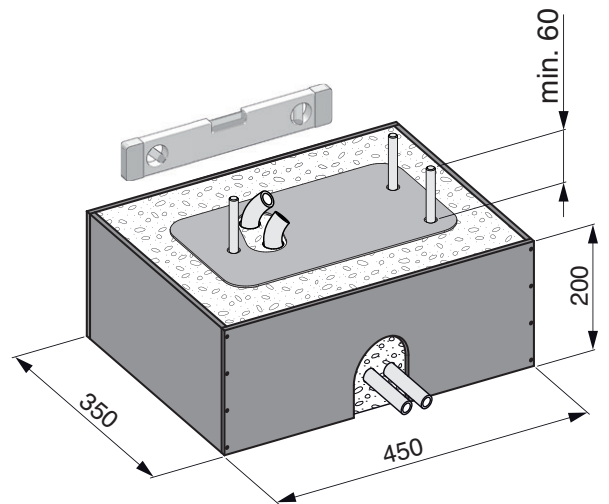
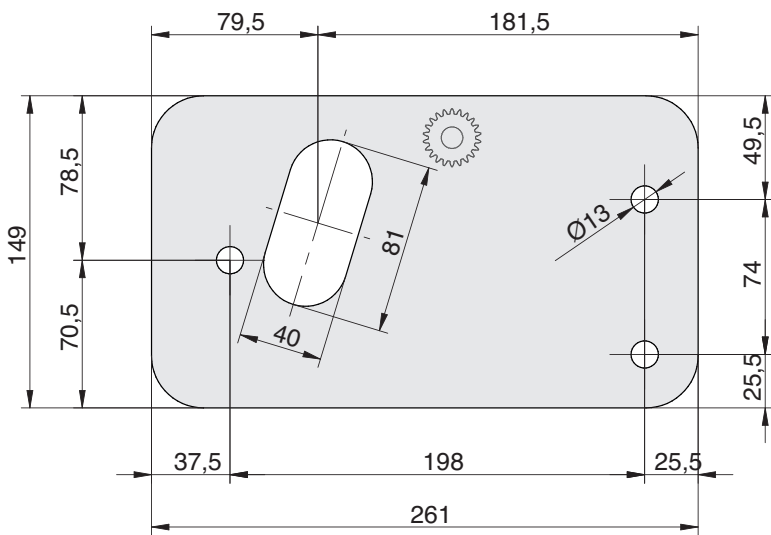

notes



DEAuser



DEAuser is the app for **private users** that allows activation of automation at **close proximity** via Bluetooth.

By installing the NET-NODE on all devices with NETLINK technology, users can control their automations through their smart devices.

To be used with:



Art. NET-NODE 2.0
Cod. 677642



DEAinstaller



DEAinstaller is the App dedicated to the **professional installer** and allows Installers to program and manage DEA automations on-site in a simple and intuitive way from their smart devices.

If you use it with the NET-NODE you can:

- ✓ keep a **data backup** of all installations
- ✓ easily adjust the **parameters** of control boards
- ✓ update the **firmware**
- ✓ program the **maintenance**
- ✓ manage or customise the **remotes**
- ✓ read **technical manuals** or have a look at the **electrical connections**
- ✓ control the **inputs** and **output** of the control boards
- ✓ **control** the automation with the App

To be used with:



Art. NET-NODE 2.0
Cod. 677642



Generic accessories

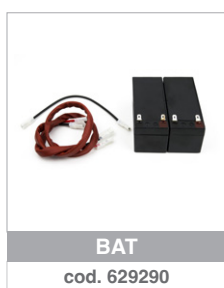
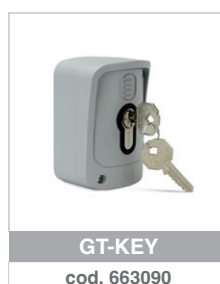

#safeasyoulike!

Non-copyable remotes!

GTI remotes are multi-function. They have three coding possibilities: DIP SWITCH, Rolling Code and D.A.R.T. the new DEA advanced coding.

You can customise the code of the remotes to guarantee the maximum security to your customer.

D. DEA
A. Advanced
R. Rolling Code
T. Transmission

Looking for **total safety**?
With **NET-BOX** each installer can customise the code of your GTI remotes.



#colourasyoulike!

Choose your favorite colour!

GTI remotes can be customised with button kits in seven colours: green, light green, blue, pink, yellow, orange and purple.



Note: button kits are supplied in packs of 5. The remote must be ordered separately.



NETLINK

is our technology applied to DEA devices for the smart management of your installations, both **locally** and **remotely**.



Our range

Automations for sliding gates



Automations for sectional doors

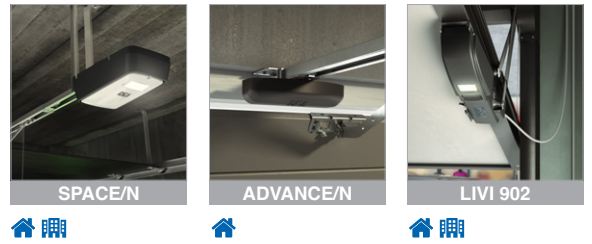

Automations for swing gates



Automations for industrial gates

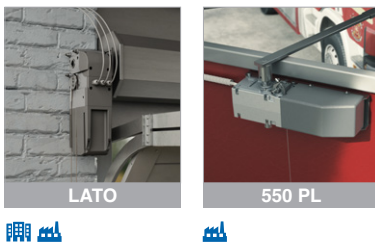

Barriers



Bollards

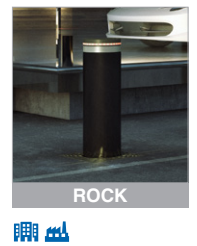

HEADQUARTER
DEA SYSTEM S.p.A.
Via della Tecnica, 6 - 36013 Piovene Rocchette (VI) - ITALY
☎ + 39.0445.55.07.89 - 📠 + 39.0445.55.02.65
info@deasystem.com - www.deasystem.com

Branches > Italia, France, United Kingdom, Ireland, España,
Portugal, Polska, Deutschland, Беларусь